

DR-100S

Simplified Voyage Data Recorder (S-VDR)

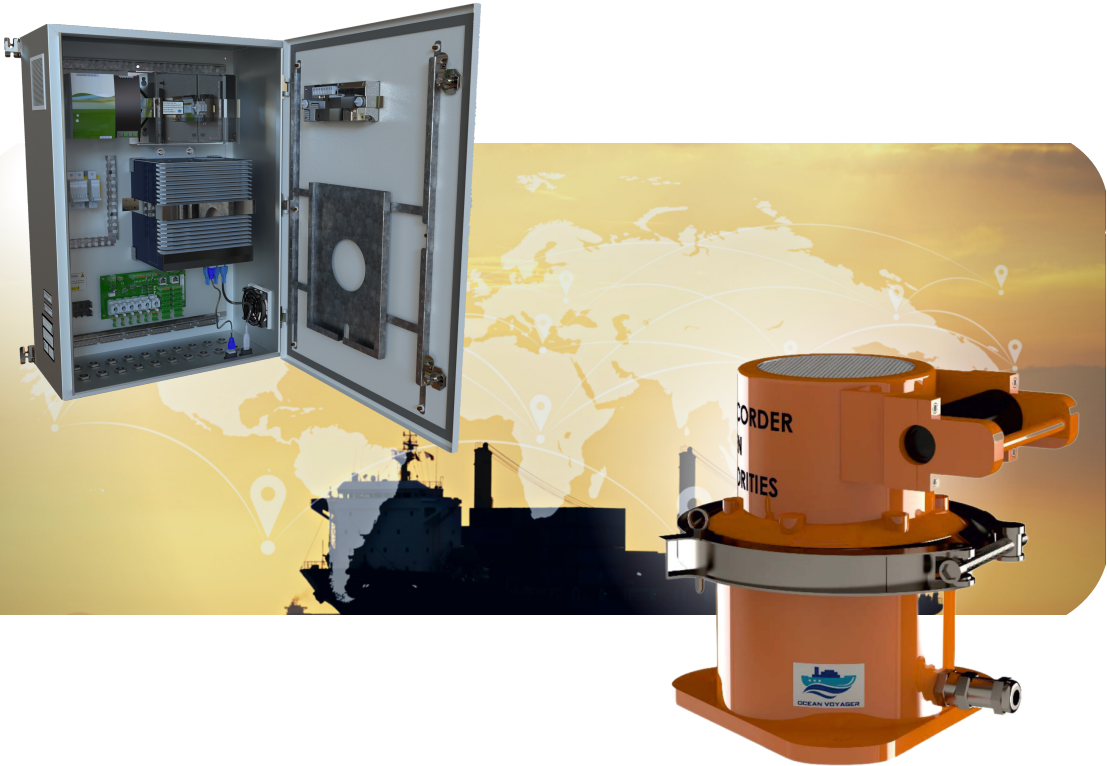

- ⚙️ Easy to install and maintenance
- ⚙️ Flexible and extendible
- ⚙️ Low hardware cost
- ⚙️ High reability and stability
- ⚙️ High service quality
- ⚙️ Comply with the latest standarts

System Diagram

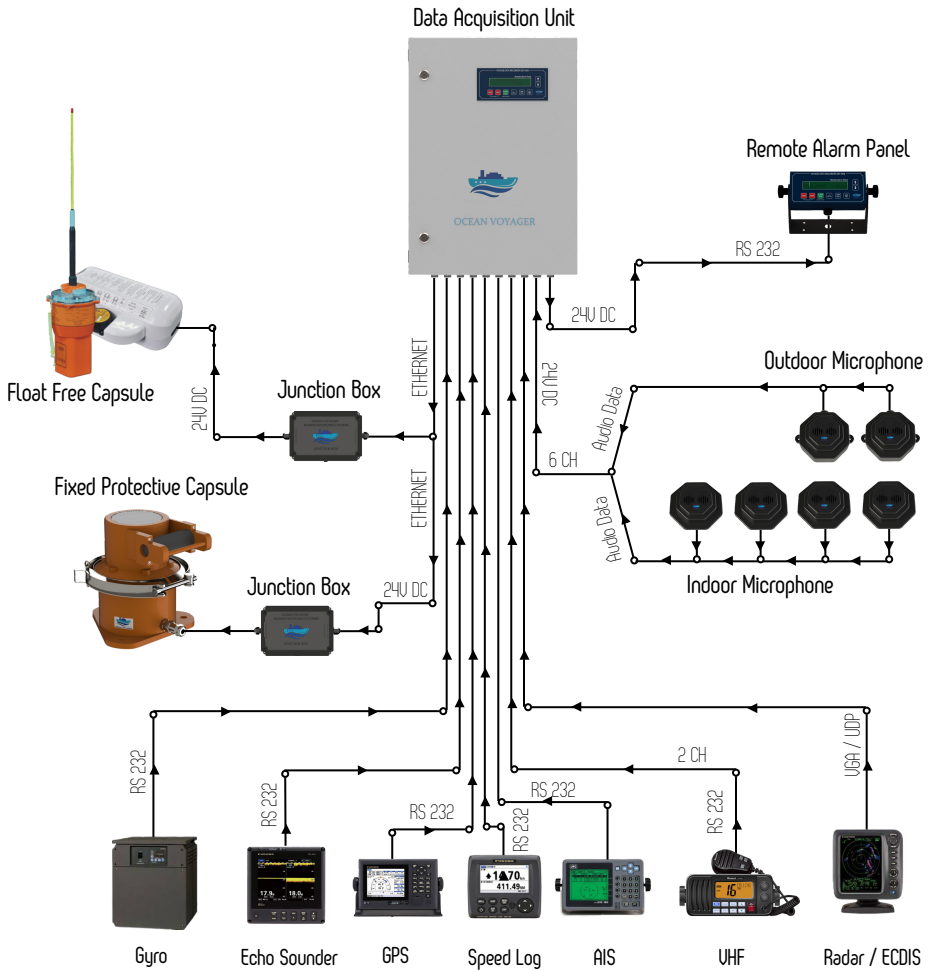

The required ones for S-VDR

- Equipped of capsule of one type of fixed type or float free type
- Download data for 12 hours in FPC or FFC
- Recording up to 24 hours data in Data Acquisition Unit
- Image recording of up to 1 Channel Radar / ECDIS
- Recording of AIS, GPS, Echo Sounder, Gyro and Speed Log NMEA data
- Audio recording up to 6 ch of Bridge Audio
- Audio recording up to 2 ch of VHF Audio
- Live Player software allows for real-time data monitoring as well as data playback with a PC at later time

Standarts

The DR-100S is a Simplified Voyage Data Recorder that comply with the all IMO performance standarts and offer additional tracking and monitoring features;

Regulations:

2014/90 EU, (EU) 2021/1158, SOLAS 74 Reg. V/18, SOLAS 74 Reg. X/3, IMO Res. MSC.36(63)-(1994 HSC Code) 13, IMO Res. MSC.97(73)-(2000 HSC Code) 13, EN 60945:2002, EN 61162-1:2016, EN 61162-2:1998, EN61162-450:2018, EN 61996-2:2008, EN 62288:2014, EN IEC 62923-1:2018, EN IEC 62923-2:2018

Performance Requirements:

2014/90 EU, 2021/1158 (EU), SOLAS 74 Reg. V/20, IMO Res.A.694(17), IMO Res. MSC.36(63) - (1994 HSC Code) 13, IMO Res. MSC.97(73) - (2000 HSC Code) 13, IMO Res. MSC.191(79), IMO Res. MSC.302(87), IMO Res. MSC.333(90).

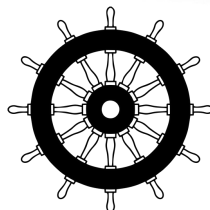

Technical Specifications

DR-100S TECHNICAL SPECIFICATIONS

Name	Simplified Voyage Data Recorder (S-VDR) System
Model	DR-100S

Remote Alarm Panel	TFT- LCD Display, Built-in Speaker, Push Button, Illumination, Touch Panel
Model	DR-106

Sensor Data	Date & Time, Ship's Position, Speed, Heading, Depth, AIS	
Audio Data	Microphone, VHF	
Image Data	Radar / ECDIS	
Recording Time	Solid State Drive	Up to 24 hours Data Recording, 128 GB TB Capacity
	USB Emergency Backup Disk	Up to 4 Hours Data Recording, 32 GB Capacity
	Fixed Protective Capsule	Up to 12 hours Data Recording, 256 GB TB Capacity
	Float Free Capsule	Up to 12 hours Data Recording, 256 GB TB Capacity
Data Recording Interval	Sensor Data	Depends on the Input from Sensor (Normally 1 Seconds)
	Audio Data	Continuous
	Image Data	1 Image / 15 Seconds

Serial Port	IEC61162-1 (38400bps)	IEC61162-2 (4800bps)
LAN	IEC61162-450	
Microphone Audio Input	6 Ports	
VHF Audio Input	2 Ports	
Radar / ECDIS Input	UDP or VGA / DVI / HDMI / YPbPr	

Data Acquisition Unit	AC 110 - 240V, 10A, 50/60HZ
LAN	IEC61162-450
Remote Alarm Panel	DC 24V
Microphone Units	DC 24V
Ship's Emergency Supply	DC 24V

DR-100S STANDARTUNITS

NO	Component	Part	DR-100S
1	Data Acquisition Unit	DR-103	1 Pcs
2	Remote Alarm Panel	DR-106	1 Pcs
3	Indoor Microphone Unit	DR-101	4 Pcs
4	Outdoor Microphone Unit	DR-117	2 Pcs
5	Fixed Protective Capsule	OVM-6000	1 Pcs
6	Junction Box	DR-119	1 Pcs

DR-100S ADDITIONAL UNITS

NO	Component	Part	DR-100S
1	Video Interface Unit	RMSD-1105	1 Pcs
2	Float Free Capsule	OVM-1000	1 Pcs
** If S-VDR, it is enough to use one of the capsules			

VDR App

DR-100S has a unique software designed for maximum performance. Users are able to view live data by using VDR application.

Live Data Screen

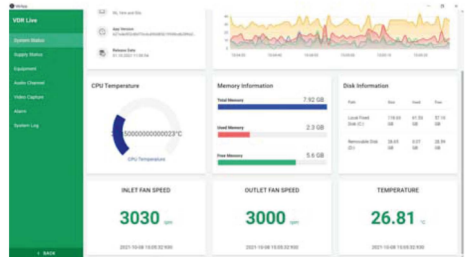
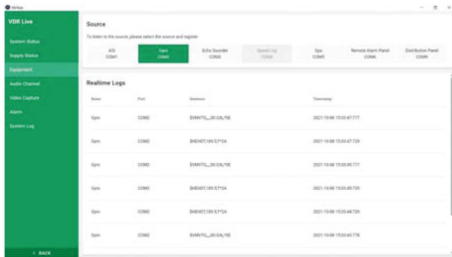

Player Screen

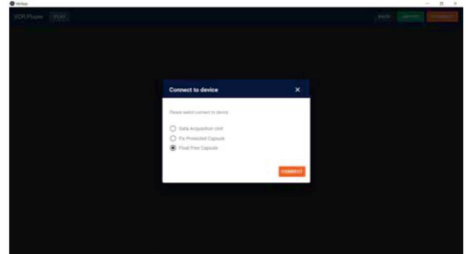
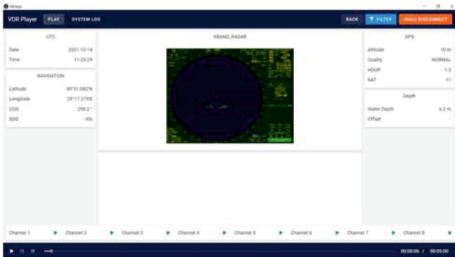

Configuration Screen

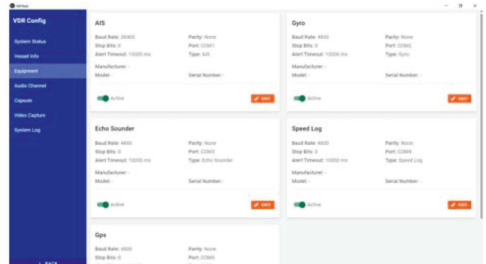
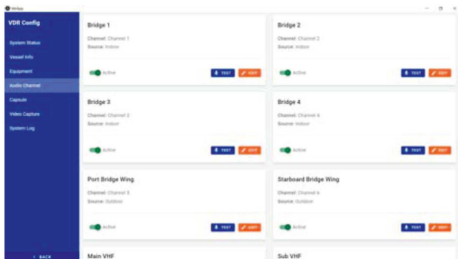

Dimensions

Data Acquisition Unit (DAU) DR-102 / DR-102R

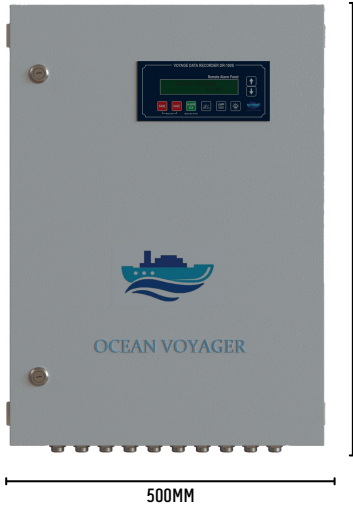

Indoor Microphone Unit (IMU) DR-101

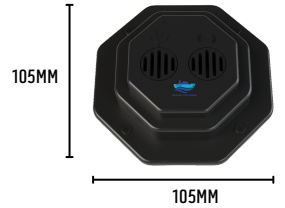

Outdoor Microphone Unit (OMU) DR-117

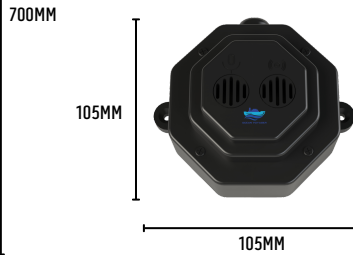

Remote Alarm Panel (RAP) DR-106

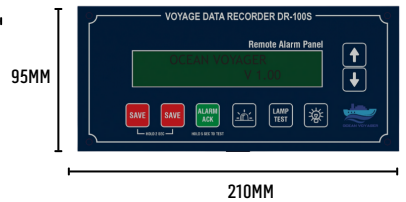

Float Free Capsule (FFC)



Fixed Protective Capsule (FPC) OVM-6000

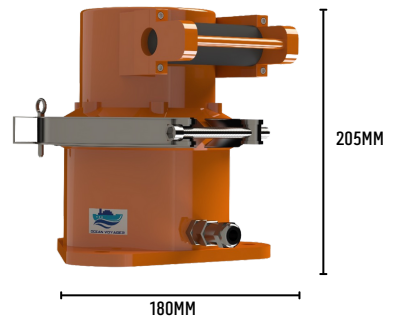

Ocean Voyager Co., Ltd.

Phone (1): +90 535 456 67 88

Phone (2): +90 535 456 67 78

Website: www.oceanvoyagermarine.com

Email (General): info@oceanvoyagermarine.com

Email (Sales): sales@oceanvoyagermarine.com

Address: Güzelyalı, Sahil Bulvarı No: 88/2

34903 Pendik/İstanbul